

NOVOSENSE

NOVOSENSE Industrial Control Solution

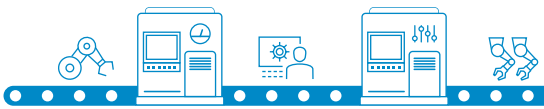



NOVOSENSE: Highly Robust and Reliable Analog and Mixed Signal Chip Company

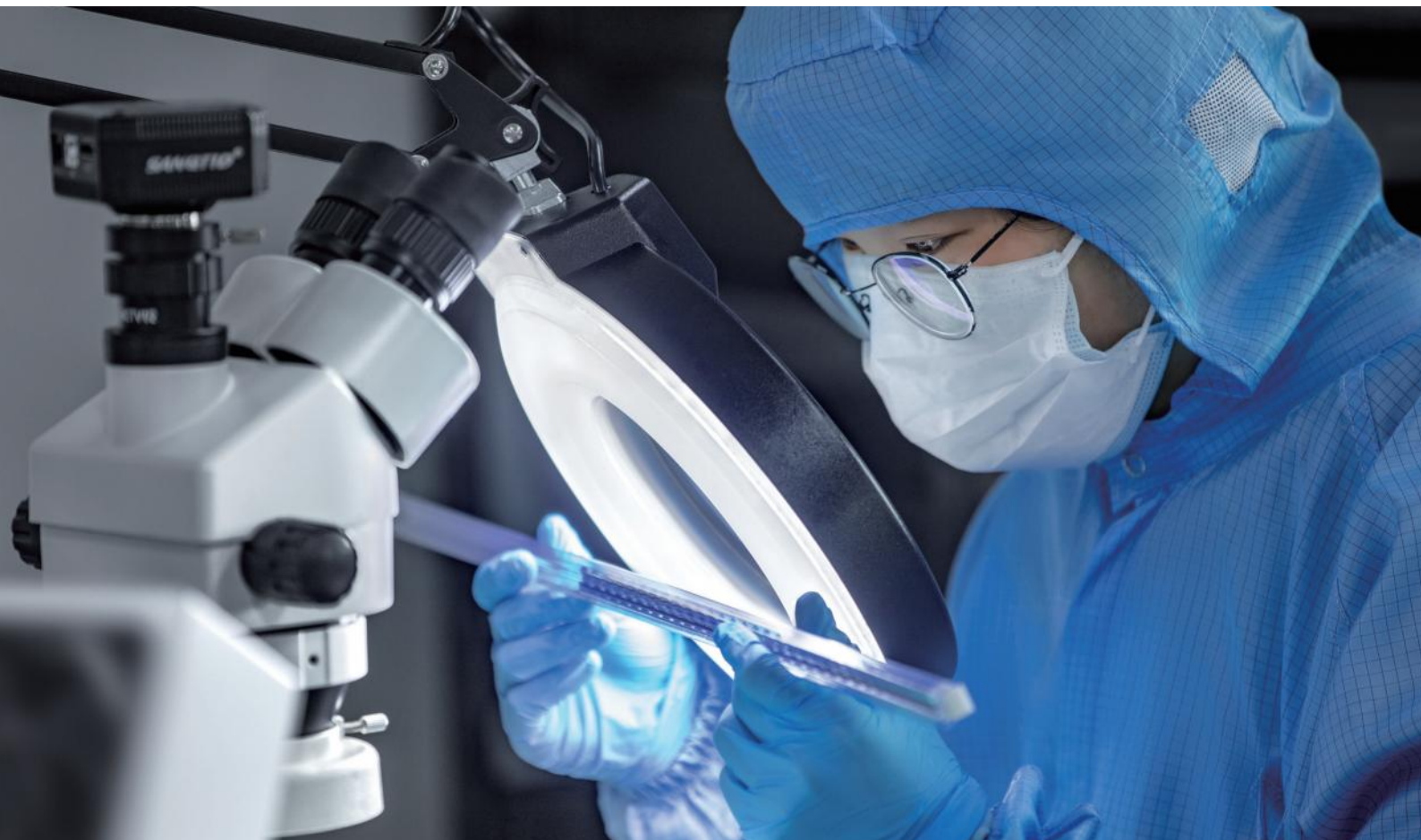

NOVOSENSE Microelectronics (NOVOSENSE, SSE Stock Code 688052) is a highly robust & reliable analog and mixed signal chip company. Since its establishment in 2013, the company has been focusing on sensor, signal chain, and power management, providing comprehensive semiconductor products and solutions, which are widely used in automotive, industrial, information communication and consumer electronics markets.

With the mission of "Sense & Drive the Future, Build a Green, Smart and Connected World with Semiconductors", the company is committed to providing chip-level solutions to link the digital world and the real world.

For more information and sample application, please visit: www.novosns.com















NOVOSENSE Products for Industrial Control Applications

Industrial Control System	Energy Control Unit	Smart Wattmeter	Concentrator	FTU	DTU	PDU	PLC	Stepper Motor	Industrial Frequency Converter	Servo	BTS Battery Component Capacity
Hall Current Sensor	√	√	√	√	√	√	√	√	√	√	√
Operational Amplifier	√	√	√	√	√	√	√	√	√	√	√
ADC							√				
Pressure Sensor							√	√			
Temperature Sensor			√		√	√	√	√	√	√	√
CAN Transceiver	√		√	√	√	√	√		√	√	√
RS485 Transceiver	√	√	√	√	√	√	√	√	√	√	√
I/O Expander	√		√								√
I ² C											√
Buffer							√	√	√	√	√
Digital Isolator	√	√	√	√	√	√	√	√	√	√	√
Isolated Current/ Voltage Sensing	√	√	√	√	√	√	√	√	√	√	√
Isolated Power	√	√	√	√	√	√	√	√	√	√	√
Isolated Driver							√	√	√	√	
Non-isolated Driver							√				√
High & Low-side Switch							√				
AC-DC Switching Converter	√		√	√	√		√	√	√	√	√
DC-DC Switching Converter	√	√	√	√	√		√	√	√	√	√
LDO			√	√	√	√		√	√		
Voltage Reference				√	√	√	√		√		
Supervisor & Reset IC									√	√	



CONTENTS

	NOVOSENSE Industrial Control Solution
	Industrial Control Solution Overview
	Energy Control Unit
	Smart Wattmeter
	Concentrator
	FTU
	DTU
	PDU
	PLC
	Stepper Motor
	Industrial Frequency Converters
	Servo
	BTS Battery Component Capacity



NOVOSENSE Industrial Control Solution



Industrial Control Solution Overview

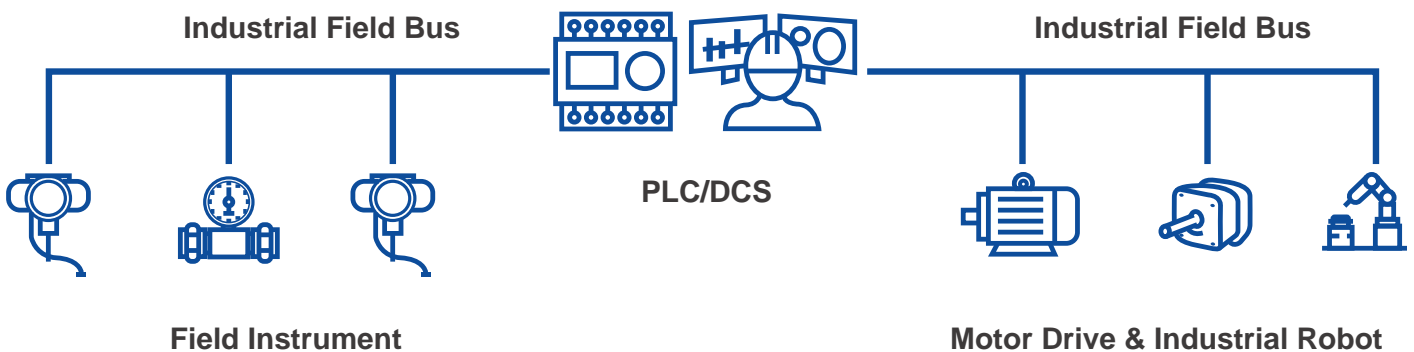

Field Instrument

- ▶ 4~20mA industrial transmitter ASIC
- ▶ Industrial field bus interface IC
- ▶ Digital isolator/Isolated power
- ▶ Temperature sensor /MEMS pressure sensor/ Magnetic position sensor
- ▶ Buck/LDO/Voltage supervisor
- ▶ General operational amplifier
- ▶ High-precision voltage reference

PLC/DCS Controller

- ▶ Analog input/output AFE
- ▶ ISO digital input and output
- ▶ Back plane board interface: mLVDS, eFuse, Hot swap
- ▶ Industrial field bus interface IC
- ▶ Digital isolation & power isolation
- ▶ Temperature sensor
- ▶ Buck/LDO/Voltage supervisor
- ▶ General operational amplifier

Motor Driver & Industrial Robot

- ▶ IGBT & MOSFET gate driver
- ▶ ISO voltage & current sensing (ISO operational amplifier & ISO ADC)
- ▶ High-speed digital isolator
- ▶ Industrial field bus and encoder bus interface IC
- ▶ General operational amplifier
- ▶ High-precision voltage reference
- ▶ Analog input/output AFE
- ▶ ISO digital input and output
- ▶ Temperature sensor
- ▶ Magnetic encoder sensor & TMR switch
- ▶ Buck/LDO/Voltage supervisor



Energy Control Unit

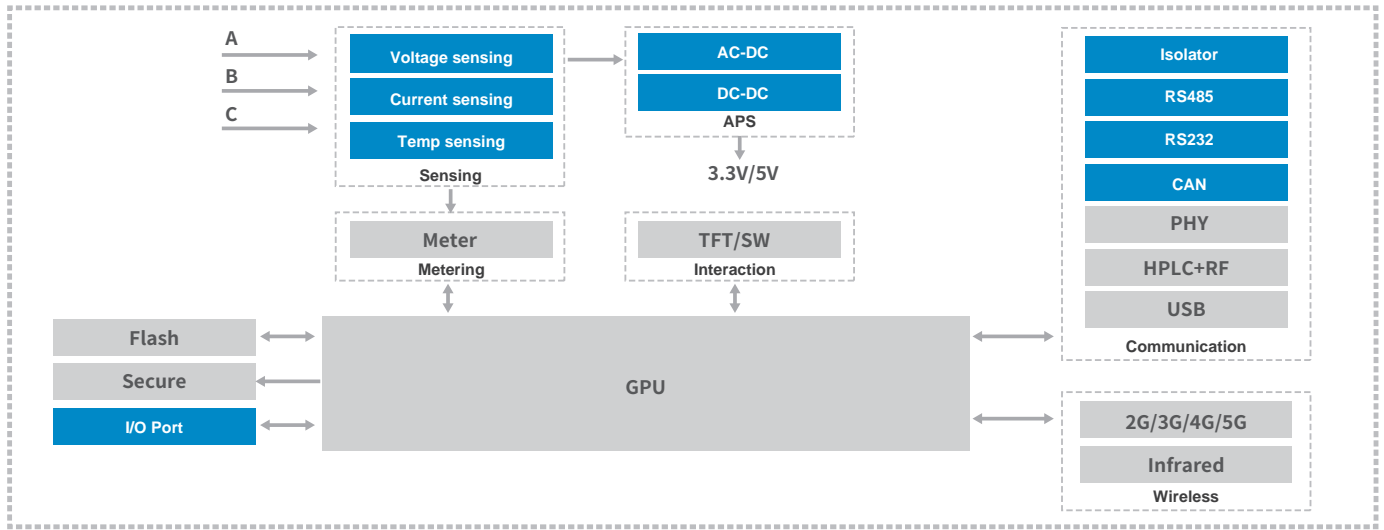

NOVOSENSE Part Number	Product Description	Application
NSM201x	Integrated Hall current sensor	PFC current detection, high-voltage battery charging current detection
NSM211x	Integrated Hall current sensor	PFC current detection, high-voltage battery charging current detection, resonant cavity current detection
NSOPA9xxx	40V high-voltage general-purpose operational amplifier	Signal amplification/ conditioning/ active filtering
NSOPA8xxx	5.5V low-voltage general-purpose operational amplifier	Signal amplification/ conditioning/ active filtering
NSI1312	Isolated amplifier	Isolated voltage sensing
NST235, NST20, NST86, NST60	High linearity & high accuracy analog output temperature sensor	Temperature sensing
NST175	I2C interface digital temperature sensor with 27 selectable addresses, supporting SMBus alarm	Temperature sensing
NST1001, NST1002	D-NTC temperature sensor	Temperature detection
NST112x	High precision digital temperature sensor	Temperature detection
NSI82xx	Digital isolator	Digital signal isolation
NIRS21	Digital isolator	Digital signal isolation
NIRS31	Digital isolator	Digital signal isolation
NCA1051A	CAN transceiver	CAN communication
NCA1042B	CAN transceiver	CAN communication
NCA1044	CAN transceiver	CAN communication
NSI1050	Isolated CAN transceiver	Isolated CAN communication
NSI1042	Isolated CAN transceiver	Isolated CAN communication
NSI83085	Half duplex RS485 transceiver	RS485 communication
NSI83086	Full duplex RS485 transceiver	RS485 communication
NCA3176	RS485 transceiver	RS485 communication
NCA3485	Half duplex RS485 transceiver	RS485 communication
NCA9555	I ² C GPIO expander	I ² C GPIO expander
NSR28C4x	PWM controller	Aux power supply
NSR104xx	Buck	Power supply Buck
NSR31xxx, NSR33xxx, NSR35xxx	40V low I _q LDO	Power supply LDO



Smart Wattmeter

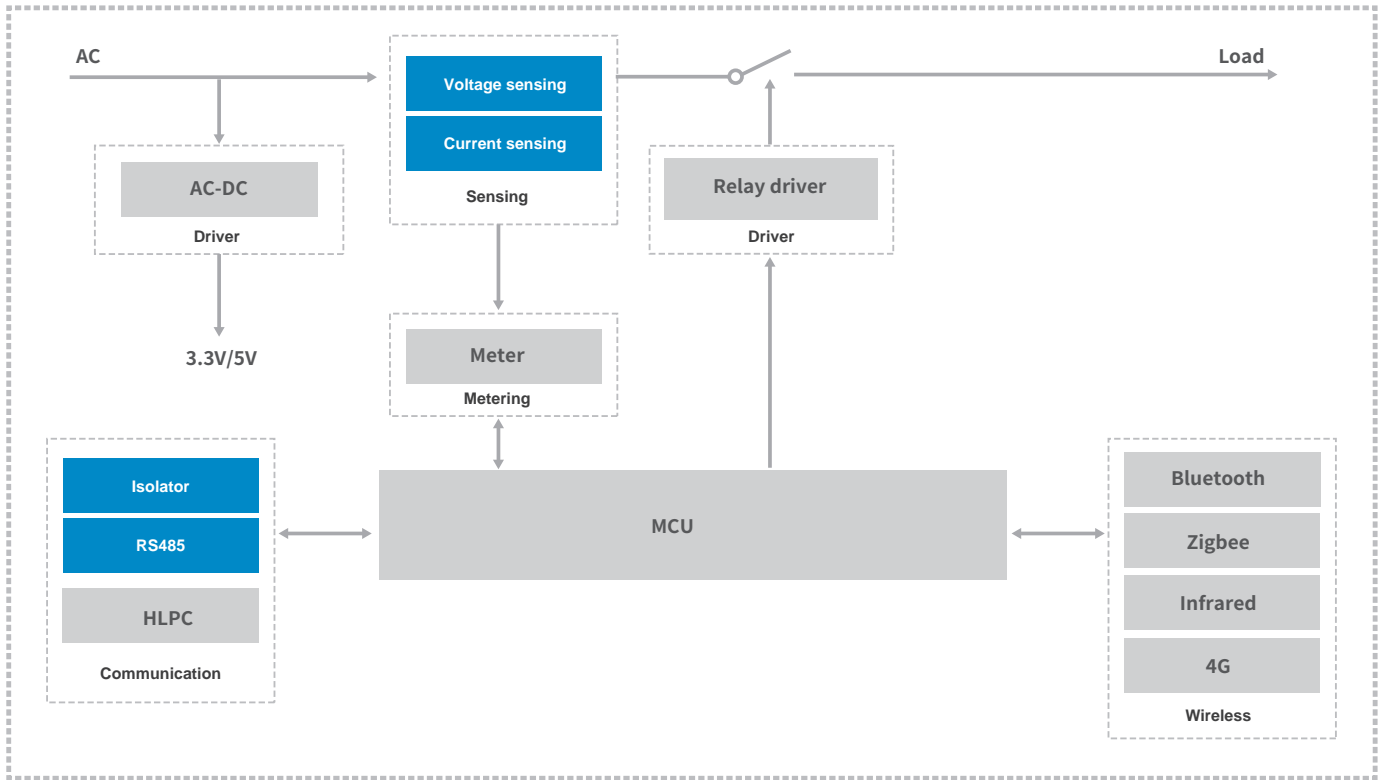

NOVOSENSE Part Number	Product Description	Application
NSM201x	Integrated Hall current sensor	PFC current detection, high-voltage battery charging current detection
NSM211x	Integrated Hall current sensor	PFC current detection, high-voltage battery charging current detection, resonant cavity current detection
NSOPA9xxx	40V high-voltage general-purpose operational amplifier	Signal amplification/ conditioning/ active filtering
NSOPA8xxx	5.5V low-voltage general-purpose operational amplifier	Signal amplification/ conditioning/ active filtering
NSI1312	Isolated amplifier	Isolated voltage sensing
NSI82xx	Digital isolator	Digital signal isolation
NIRS21	Digital isolator	Digital signal isolation
NIRS31	Digital isolator	Digital signal isolation
NSI83085	Half duplex RS485 transceiver	RS485 communication
NSI83086	Full duplex RS485 transceiver	RS485 communication
NCA3176	RS485 transceiver	RS485 communication
NCA3485	Half duplex RS485 transceiver	RS485 communication



Concentrator

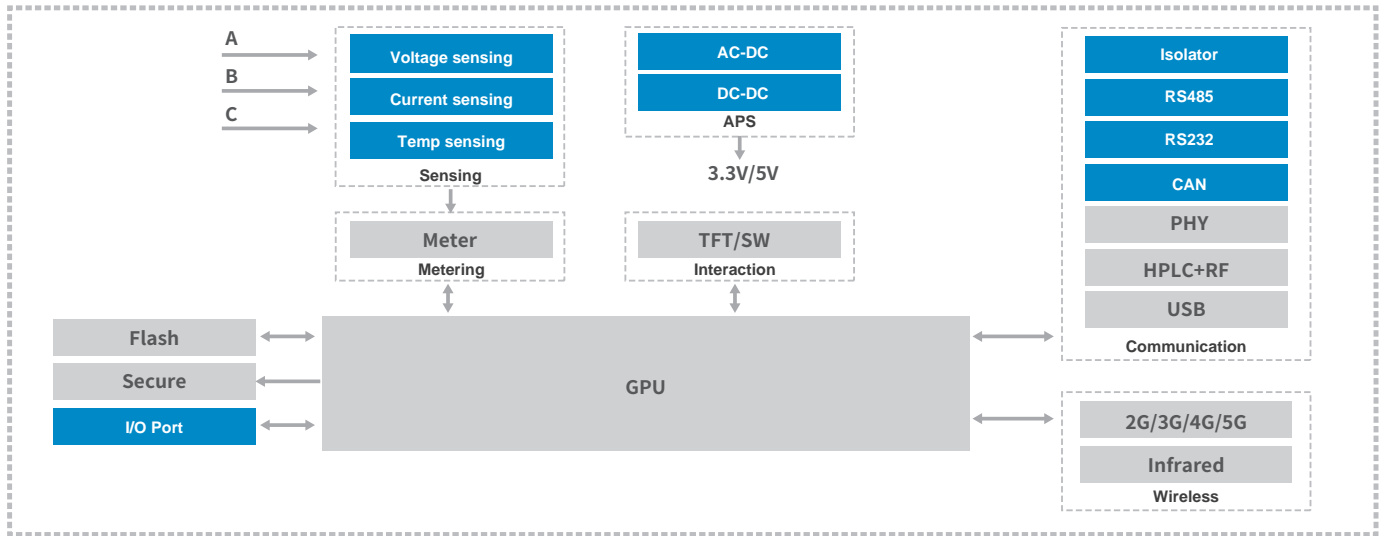

NOVOSENSE Part Number	Product Description	Application
NSM201x	Integrated Hall current sensor	PFC current detection, high-voltage battery charging current detection
NSM211x	Integrated Hall current sensor	PFC current detection, high-voltage battery charging current detection, resonant cavity current detection
NSOPA9xxx	40V high-voltage general-purpose operational amplifier	Signal amplification/ conditioning/ active filtering
NSOPA8xxx	5.5V low-voltage general-purpose operational amplifier	Signal amplification/ conditioning/ active filtering
NSI1312	Isolated amplifier	Isolated voltage sensing
NST235	High linearity & high accuracy analog output temperature sensor	Temperature sensing
NST20	High linearity & high accuracy analog output temperature sensor	Temperature sensing
NST1001	D-NTC temperature sensor	Temperature detection
NST1002	D-NTC temperature sensor	Temperature detection
NSI82xx	Digital isolator	Digital signal isolation
NIRS21	Digital isolator	Digital signal isolation
NIRS31	Digital isolator	Digital signal isolation
NCA1051A	CAN transceiver	CAN communication
NCA1042B	CAN transceiver	CAN communication
NSI1050	Isolated CAN transceiver	Isolated CAN communication
NSI1042	Isolated CAN transceiver	Isolated CAN communication
NSI83085	Half duplex RS485 transceiver	RS485 communication
NSI83086	Full duplex RS485 transceiver	RS485 communication
NCA3176	RS485 transceiver	RS485 communication
NCA3485	Half duplex RS485 transceiver	RS485 communication
NCA9555	I ² C GPIO expander	I ² C GPIO expander
NSR28C4x	PWM controller	Aux power supply
NSR104xx	Buck	Power supply Buck
NSR31xxx, NSR33xxx, NSR35xxx	40V low Iq LDO	Power supply LDO



FTU

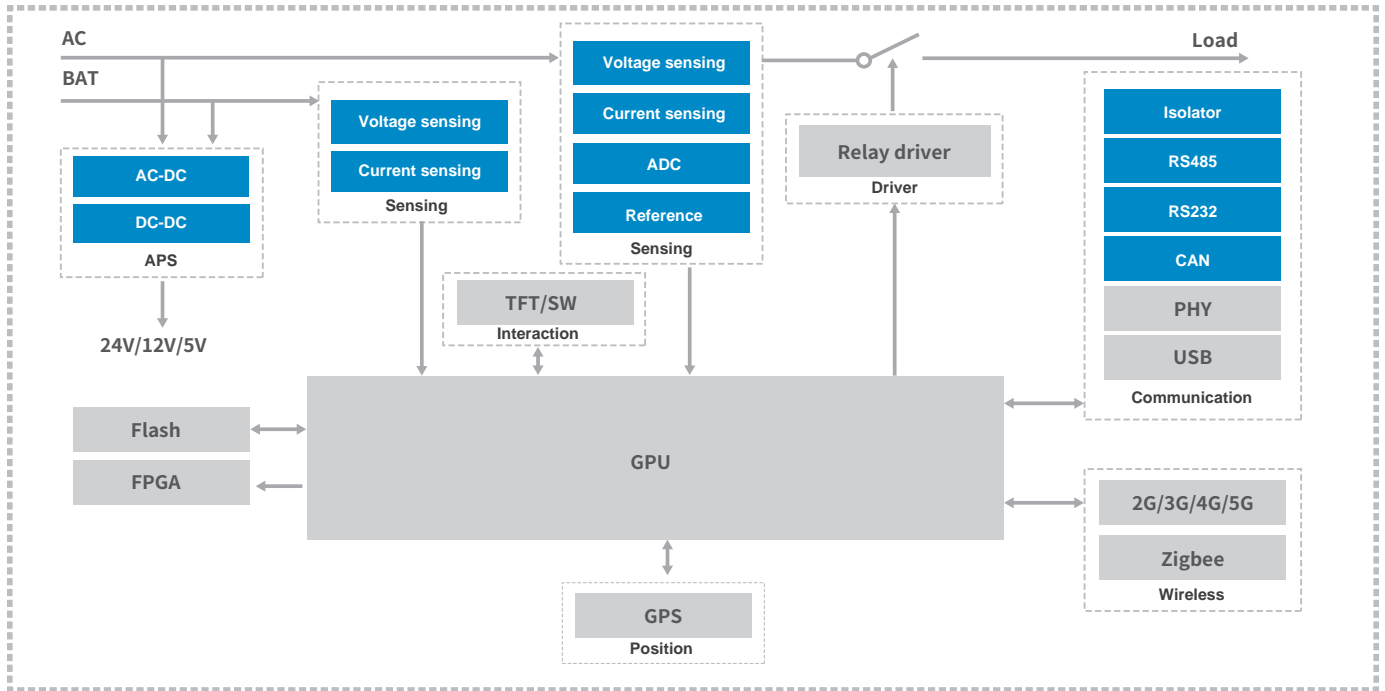

NOVOSENSE Part Number	Product Description	Application
NSI1312	Isolated amplifier	Isolated voltage sensing
NSOPA9xxx	40V high-voltage general-purpose operational amplifier	Signal amplification/ conditioning/ active filtering
NSOPA8xxx	5.5V low-voltage general-purpose operational amplifier	Signal amplification/ conditioning/ active filtering
NSM201x	Integrated Hall current sensor	PFC current detection, high-voltage battery charging current detection
NSM211x	Integrated Hall current sensor	PFC current detection, high-voltage battery charging current detection, resonant cavity current detection
NSREF30xx	High-precision voltage references	Current & voltage & temperature sensing
NSREF31xx	High-precision voltage references	Current & voltage & temperature sensing
NSI82xx	Digital isolator	Digital signal isolation
NIRS21	Digital isolator	Digital signal isolation
NIRS31	Digital isolator	Digital signal isolation
NCA1051A	CAN transceiver	CAN communication
NCA1042B	CAN transceiver	CAN communication
NSI1050	Isolated CAN transceiver	Isolated CAN communication
NSI1042	Isolated CAN transceiver	CAN communication
NSI83085	Half duplex RS485 transceiver	RS485 communication
NSI83086	Full duplex RS485 transceiver	RS485 communication
NCA3176	RS485 transceiver	RS485 communication
NCA3485	Half duplex RS485 transceiver	RS485 communication
NSR28C4x	PWM controller	Aux power supply
NSR104xx	Buck	Power supply Buck
NSR31xxx, NSR33xxx, NSR35xxx	40V low Iq LDO	Power supply LDO



DTU

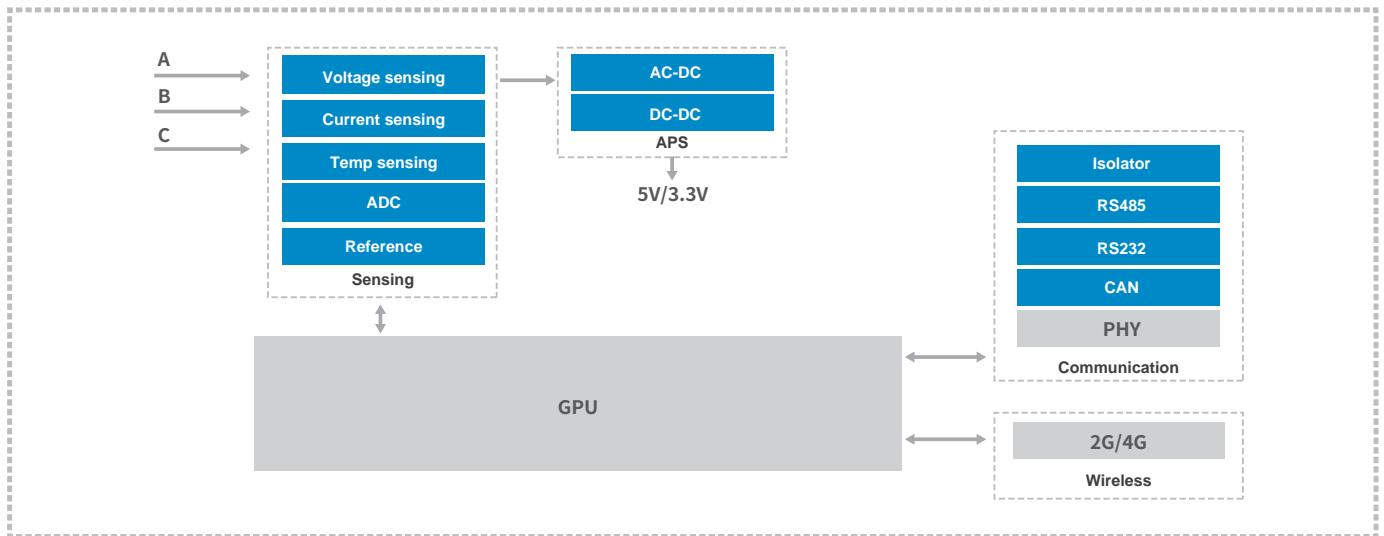

NOVOSENSE Part Number	Product Description	Application
NSM201x	Integrated Hall current sensor	PFC current detection, high-voltage battery charging current detection
NSM211x	Integrated Hall current sensor	PFC current detection, high-voltage battery charging current detection, resonant cavity current detection
NSI1312	Isolated amplifier	Isolated voltage sensing
NSOPA9xxx	40V high-voltage general-purpose operational amplifier	Signal amplification/ conditioning/ active filtering
NSOPA8xxx	5.5V low-voltage general-purpose operational amplifier	Signal amplification/ conditioning/ active filtering
NST235	High linearity & high accuracy analog output temperature sensor	Temperature sensing
NST20	High linearity & high accuracy analog output temperature sensor	Temperature sensing
NST1001	D-NTC temperature sensor	Temperature detection
NST1002	D-NTC temperature sensor	Temperature detection
NSREF30xx	High-precision voltage references	Current & voltage & temperature sensing
NSREF31xx	High-precision voltage references	Current & voltage & temperature sensing
NSI82xx	Digital isolator	Digital signal isolation
NIRS21	Digital isolator	Digital signal isolation
NIRS31	Digital isolator	Digital signal isolation
NCA1051A	CAN transceiver	CAN communication
NCA1042B	CAN transceiver	CAN communication
NSI1050	Isolated CAN transceiver	Isolated CAN communication
NSI1042	Isolated CAN transceiver	Isolated CAN communication
NSI83085	Half duplex RS485 transceiver	RS485 communication
NSI83086	Full duplex RS485 transceiver	RS485 communication
NCA3176	RS485 transceiver	RS485 communication
NCA3485	Half duplex RS485 transceiver	RS485 communication
NSR28C4x	PWM controller	Aux power supply
NSR104xx	Buck	Power supply Buck
NSR31xxx, NSR33xxx, NSR35xxx	40V low Iq LDO	Power supply LDO



PDU

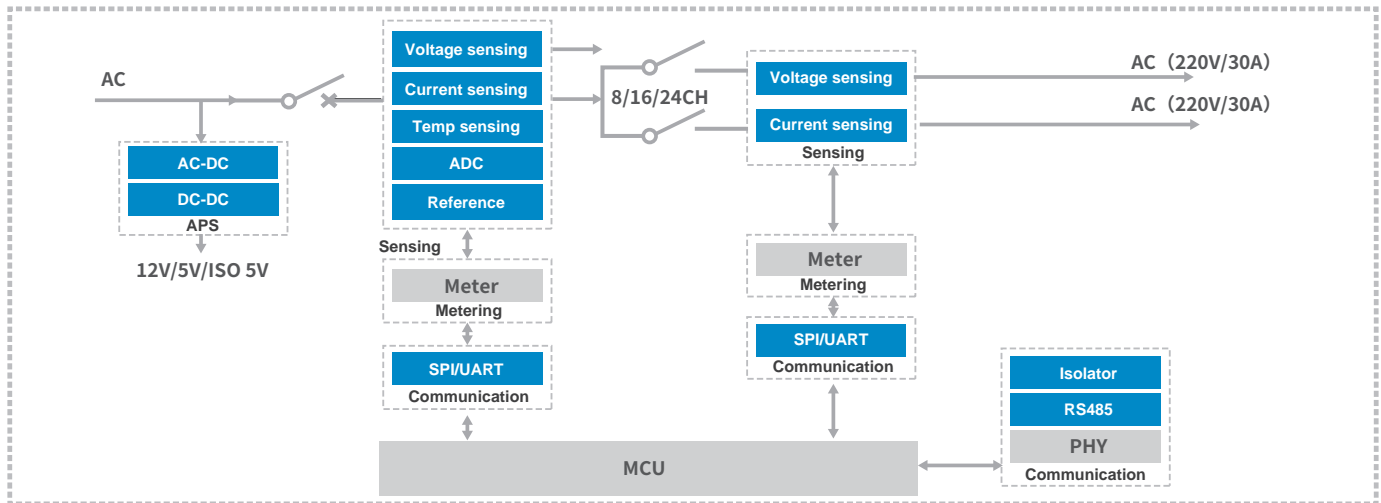

NOVOSENSE Part Number	Product Description	Application
NSM201x	Integrated Hall current sensor	PFC current detection, high-voltage battery charging current detection
NSM211x	Integrated Hall current sensor	PFC current detection, high-voltage battery charging current detection, resonant cavity current detection
NSI1312	Isolated amplifier	Isolated voltage sensing
NSOPA9xxx	40V high-voltage general-purpose operational amplifier	Signal amplification/ conditioning/ active filtering
NSOPA8xxx	5.5V low-voltage general-purpose operational amplifier	Signal amplification/ conditioning/ active filtering
NST235	High linearity & high accuracy analog output temperature sensor	Temperature sensing
NST20	High linearity & high accuracy analog output temperature sensor	Temperature sensing
NST1001	D-NTC temperature sensor	Temperature detection
NST1002	D-NTC temperature sensor	Temperature detection
NSREF30xx	High-precision voltage references	Current & voltage & temperature sensing
NSREF31xx	High-precision voltage references	Current & voltage & temperature sensing
NSI82xx	Digital isolator	Digital signal isolation
NIRS21	Digital isolator	Digital signal isolation
NIRS31	Digital isolator	Digital signal isolation
NCA1051A	CAN transceiver	CAN communication
NCA1042B	CAN transceiver	CAN communication
NSI1050	Isolated CAN transceiver	Isolated CAN communication
NSI1042	Isolated CAN transceiver	Isolated CAN communication
NSI83085	Half duplex RS485 transceiver	RS485 communication
NSI83086	Full duplex RS485 transceiver	RS485 communication
NCA3176	RS485 transceiver	RS485 communication
NCA3485	Half duplex RS485 transceiver	RS485 communication
NSI8100	I ² C digital isolator	Isolated I ² C communication
NSI8200	I ² C digital isolator	Isolated I ² C communication
NSR28C4x	PWM controller	Aux power supply
NSR104xx	Buck	Power supply Buck
NSR31xxx, NSR33xxx, NSR35xxx	40V low Iq LDO	Power supply LDO



PLC

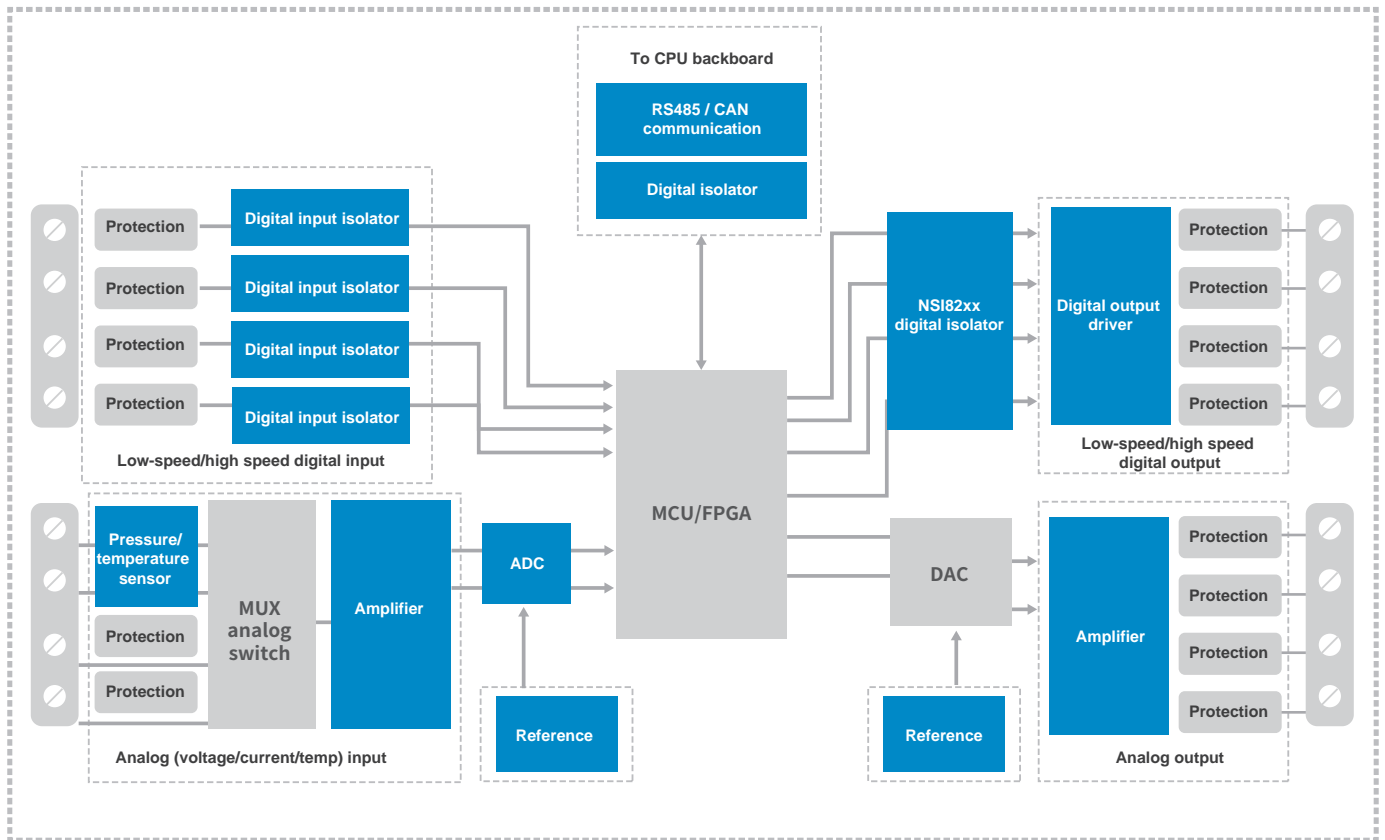

NOVOSENSE Part Number	Product Description	Application
NST1001	D-NTC temperature sensor	Temperature detection
NST1002	D-NTC temperature sensor	Temperature detection
NSC2860x	Industrial transmitter signal conditioning chip	Temperature/pressure transmitter
NSA2860x	Industrial transmitter signal conditioning chip	Temperature/pressure transmitter
NSA2862x	Industrial transmitter signal conditioning chip	Temperature/pressure transmitter
NSOPA9xxx	40V high-voltage general-purpose operational amplifier	Signal amplification/ conditioning/ active filtering
NSOPA8xxx	5.5V low-voltage general-purpose operational amplifier	Signal amplification/ conditioning/ active filtering
NSAD124x	ADC	Analog input acquisition/high precision temperature measurement (RTD, thermocouple, thermal resistance)
NSAD114x	ADC	Analog input acquisition/high precision temperature measurement (RTD, thermocouple, thermal resistance)
NSI6801	Opto-compatible single-channel isolated gate driver	MOS/IGBT/SiC isolated gate driver
NSI68515	Opto-compatible isolated single-channel driver with protection functions	MOS/IGBT/SiC isolated gate driver
NSI6801M	Single-channel isolated gate driver with Miller Clamp	MOS/IGBT/SiC isolated gate driver
NSD5604	Four-channel low-side relay and solenoid driver	Relay/valve control



NOVOSENSE Part Number	Product Description	Application
NSE11409	40V 90mohm single channel low-side driver	Relay/solenoid valve/load switch
NSD11416, NSD12416	Single/dual-channel 160mΩ low side driver	Relay/valve control
NSI82xx	Digital isolator	Digital signal isolation
NSI8608	Isolated digital input	Isolated digital signal input
NCA1051A	CAN transceiver	CAN communication
NCA1042B	CAN transceiver	CAN communication
NSI1050	Isolated CAN transceiver	Isolated CAN communication
NSI1042	Isolated CAN transceiver	Isolated CAN communication
NSI83085	Half duplex RS485 transceiver	RS485 communication
NSI83086	Full duplex RS485 transceiver	RS485 communication
NCA3176	RS485 transceiver	RS485 communication
NCA3485	Half duplex RS485 transceiver	RS485 communication
NSREF30xx	High-precision voltage references	Current & voltage & temperature sensing
NSREF31xx	High-precision voltage references	Current & voltage & temperatuer sensing
NCA8244	Buffer	Improve driver ability of bus-oriented receivers and transmitters, clock drivers
NCA8245	Buffer	Improve driver ability of bus-oriented receivers and transmitters, clock drivers
NSAD124x	ADC	Analog input acquisition/high precision temperature measurement (RTD, thermocouple, thermal resistance)
NSAD114x	ADC	Analog input acquisition/high precision temperature measurement (RTD, thermocouple, thermal resistance)

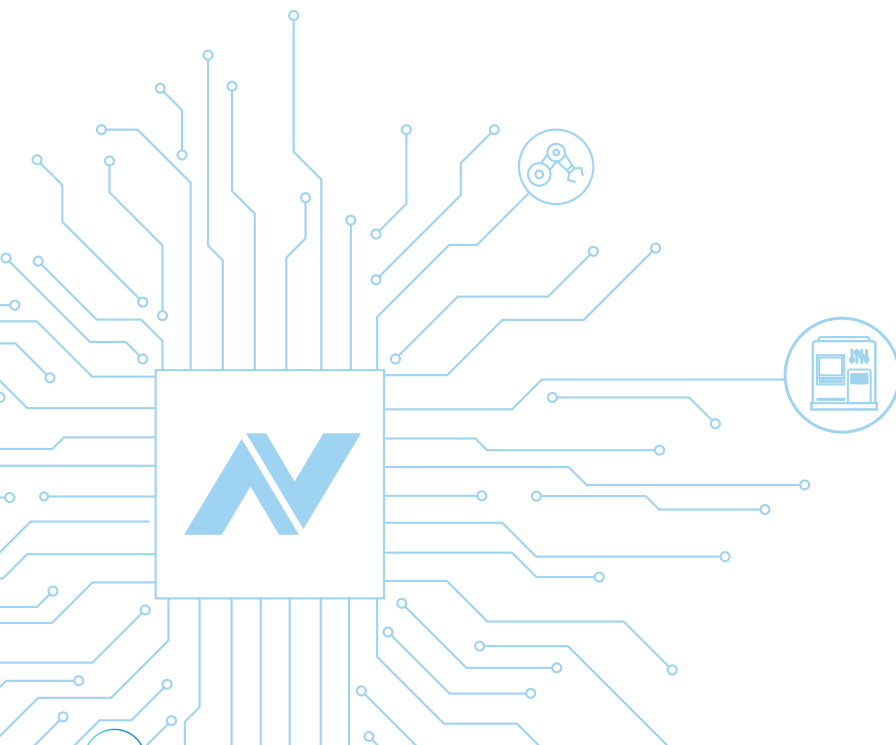



Stepper Motor

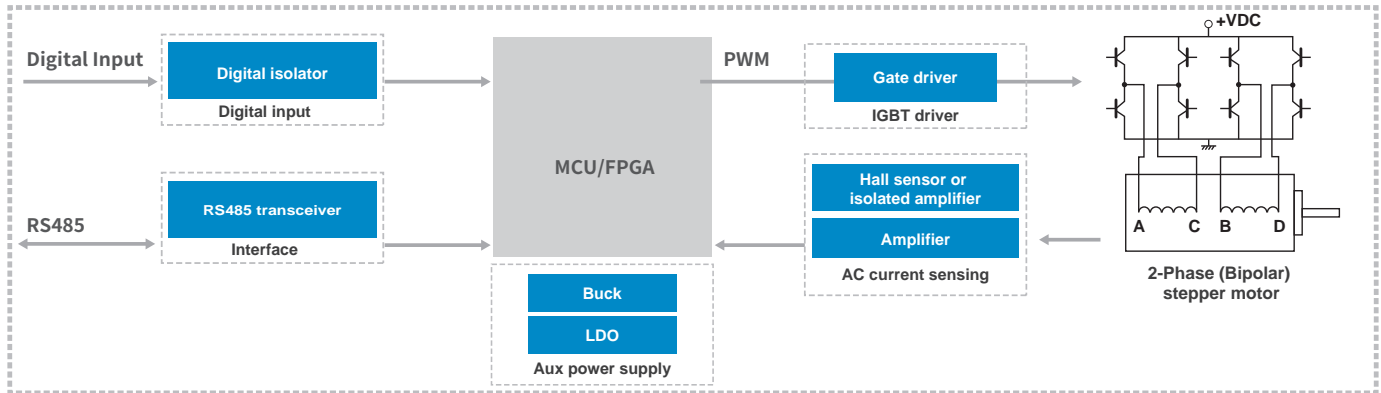

NOVOSENSE Part Number	Product Description	Application
NSM2011	Integrated Hall current sensor	PFC current detection, high-voltage battery charging current detection
NSM2013	Integrated Hall current sensor	PFC current detection, high-voltage battery charging current detection
NSM2015	Integrated Hall current sensor	PFC current detection, high-voltage battery charging current detection
NSM2017	Integrated Hall current sensor	PFC current detection, high-voltage battery charging current detection
NSM2019	Integrated Hall current sensor	PFC current detection, high-voltage battery charging current detection
NSM2113	Integrated Hall current sensor	PFC current detection, high-voltage battery charging current detection, resonant cavity current detection
NSI1400	Isolated amplifier	Isolated current sensing
NSI1300	Isolated amplifier	Isolated current sensing
NSI1200C	Isolated amplifier	Isolated current sensing
NSI1312	Isolated amplifier	Isolated voltage sensing
NSI1311	Isolated amplifier	Isolated voltage sensing
NSOPA9xxx	40V high-voltage general-purpose operational amplifier	Signal amplification/ conditioning/ active filtering
NSOPA8xxx	5.5V low-voltage general-purpose operational amplifier	Signal amplification/ conditioning/ active filtering
NST1001	D-NTC temperature sensor	Temperature detection
NST1002	D-NTC temperature sensor	Temperature detection
NSC2860x	Industrial transmitter signal conditioning chip	Temperature/pressure transmitter
NSA2860x	Industrial transmitter signal conditioning chip	Temperature/pressure transmitter
NSA2862x	Industrial transmitter signal conditioning chip	Temperature/pressure transmitter
NSI6801	Opto-compatible single-channel isolated gate driver	MOS/IGBT/SiC isolated gate driver
NSI68515	Opto-compatible isolated single-channel driver with protection functions	MOS/IGBT/SiC isolated gate driver
NSI6801M	Single-channel isolated gate driver with Miller Clamp	MOS/IGBT/SiC isolated gate driver
NCA8244	Buffer	Improve driver ability of bus-oriented receivers and transmitters, clock drivers
NCA8245	Buffer	Improve driver ability of bus-oriented receivers and transmitters, clock drivers
NSI8608	Isolated digital input	Isolated digital signal input
NSI82xx	Digital isolator	Digital signal isolation
NSI83085	Half duplex RS485 transceiver	RS485 communication
NSI83086	Full duplex RS485 transceiver	RS485 communication
NCA3176	RS485 transceiver	RS485 communication
NCA3485	Half duplex RS485 transceiver	RS485 communication
NSR104xx	Buck	Power supply Buck
NSR31xxx, NSR33xxx, NSR35xxx	40V low Iq LDO	Power supply LDO



Industrial Frequency Converters

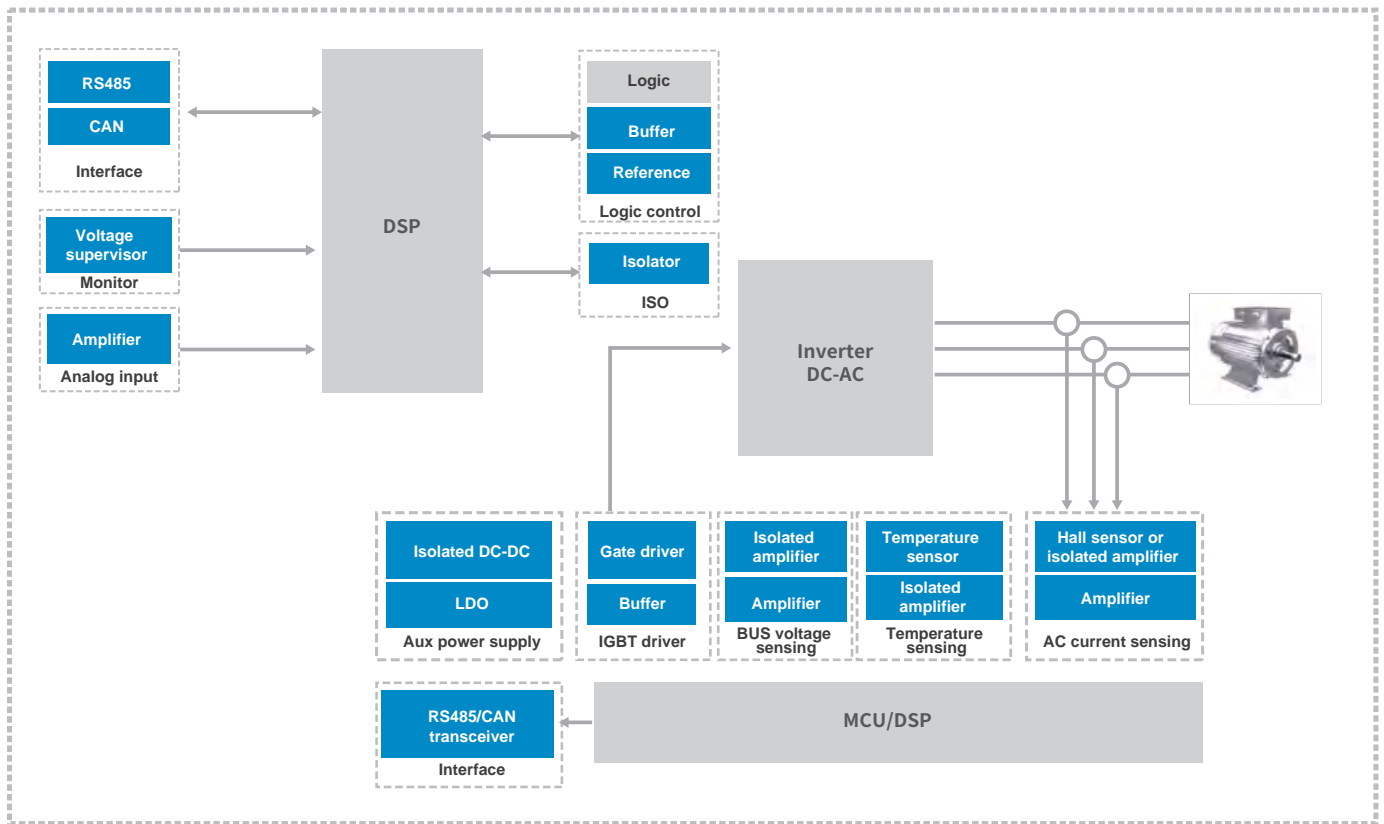

NOVOSENSE Part Number	Product Description	Application
NSM2011	Integrated Hall current sensor	PFC current detection, high-voltage battery charging current detection
NSM2013	Integrated Hall current sensor	PFC current detection, high-voltage battery charging current detection
NSM2015	Integrated Hall current sensor	PFC current detection, high-voltage battery charging current detection
NSM2017	Integrated Hall current sensor	PFC current detection, high-voltage battery charging current detection
NSM2019	Integrated Hall current sensor	PFC current detection, high-voltage battery charging current detection
NSM2113	Integrated Hall current sensor	PFC current detection, high-voltage battery charging current detection, resonant cavity current detection
NSM2012	Integrated Hall current sensor	PFC current detection, high-voltage battery charging current detection
NSM2311	Integrated Hall current sensor	PFC current detection, high-voltage battery charging current detection
NSI1400	Isolated amplifier	Isolated current sensing
NSI1300	Isolated amplifier	Isolated current sensing
NSI1200C	Isolated amplifier	Isolated current sensing
NSI1312	Isolated amplifier	Isolated voltage sensing
NSI1311	Isolated amplifier	Isolated voltage sensing

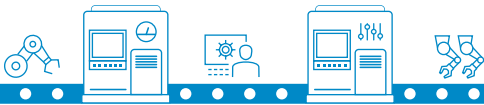

NOVOSENSE Part Number	Product Description	Application
NSI22C11	Isolated single-ended comparator	Over voltage and over temperature protection
NSI22C12	Isolated window comparator	Over current protection
NSOPA9xxx	40V high-voltage general-purpose operational amplifier	Signal amplification/ conditioning/ active filtering
NSOPA8xxx	5.5V low-voltage general-purpose operational amplifier	Signal amplification/ conditioning/ active filtering
NST1001	D-NTC temperature sensor	Temperature detection
NST1002	D-NTC temperature sensor	Temperature detection
NSR104xx	Buck	Power supply Buck
NSR31xxx, NSR33xxx, NSR35xxx	40V low Iq LDO	Power supply LDO
NSREF30xx	High-precision voltage references	Current & voltage & temperature sensing
NSREF31xx	High-precision voltage references	Current & voltage & temperature sensing
NSR7808	Voltage supervisor	MCU core voltage supervisor
NSI82xx	Digital isolator	Digital signal isolation
NIRS21	Digital isolator	Digital signal isolation
NIRS31	Digital isolator	Digital signal isolation
NCA1051A	CAN transceiver	CAN communication
NCA1042B	CAN transceiver	CAN communication
NSI1050	Isolated CAN transceiver	Isolated CAN communication
NSI1042	Isolated CAN transceiver	Isolated CAN communication
NSI83085	Half duplex RS485 transceiver	RS485 communication
NSI83086	Full duplex RS485 transceiver	RS485 communication
NCA3176	RS485 transceiver	RS485 communication
NCA3485	Half duplex RS485 transceiver	RS485 communication
NSI6801	Opto-compatible single-channel isolated gate driver	MOS/IGBT/SiC isolated gate driver
NSI68515	Opto-compatible isolated single-channel driver with protection functions	MOS/IGBT/SiC isolated gate driver
NSI6801M	Single-channel isolated gate driver with Miller Clamp	MOS/IGBT/SiC isolated gate driver
NCA8244	Buffer	Improve driver ability of bus-oriented receivers and transmitters, clock drivers



Servo

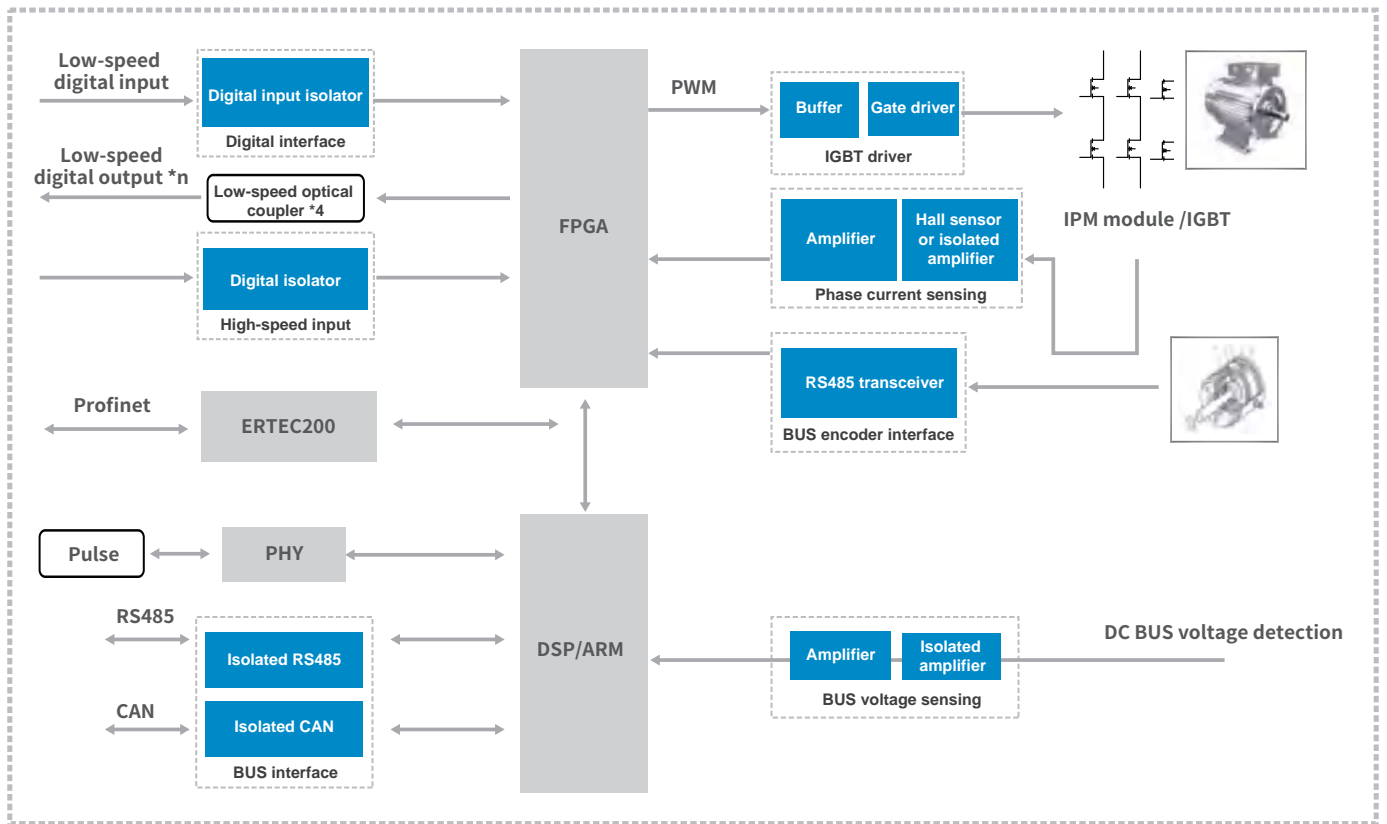

NOVOSENSE Part Number	Product Description	Application
NSM2011	Integrated Hall current sensor	PFC current detection, high-voltage battery charging current detection
NSM2013	Integrated Hall current sensor	PFC current detection, high-voltage battery charging current detection
NSM2015	Integrated Hall current sensor	PFC current detection, high-voltage battery charging current detection
NSM2017	Integrated Hall current sensor	PFC current detection, high-voltage battery charging current detection
NSM2019	Integrated Hall current sensor	PFC current detection, high-voltage battery charging current detection
NSM2113	Integrated Hall current sensor	PFC current detection, high-voltage battery charging current detection, resonant cavity current detection
NSI1400	Isolated amplifier	Isolated current sensing
NSI1300	Isolated amplifier	Isolated current sensing
NSI1200C	Isolated amplifier	Isolated current sensing
NSI1312	Isolated amplifier	Isolated voltage sensing
NSI1311	Isolated amplifier	Isolated voltage sensing
NSI1306	Isolated ADC	Isolated current sensing
NSI1305	Isolated ADC	Isolated current sensing

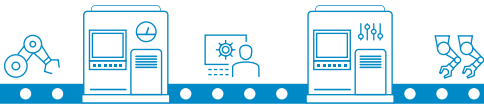

NOVOSENSE Part Number	Product Description	Application
NSI1303	Isolated ADC	Isolated current sensing
NSI22C11	Isolated single-ended comparator	Over voltage and over temperature protection
NSI22C12	Isolated window comparator	Over current protection
NSOPA9xxx	40V high-voltage general-purpose operational amplifier	Signal amplification/ conditioning/ active filtering
NSOPA8xxx	5.5V low-voltage general-purpose operational amplifier	Signal amplification/ conditioning/ active filtering
NST1001	D-NTC temperature sensor	Temperature detection
NST1002	D-NTC temperature sensor	Temperature detection
NSI6801	Opto-compatible single-channel isolated gate driver	MOS/IGBT/SiC isolated gate driver
NSI68515	Opto-compatible isolated single-channel driver with protection functions	MOS/IGBT/SiC isolated gate driver
NSI6801M	Single-channel isolated gate driver with Miller Clamp	MOS/IGBT/SiC isolated gate driver
NCA8244	Buffer	Improve driver ability of bus-oriented receivers and transmitters, clock drivers
NSI8608	Isolated digital input	Isolated digital signal input
NSI82xx	Digital isolator	Digital signal isolation
NSI8260	Digital isolator	Digital signal isolation
NSI8266	Digital isolator	Digital signal isolation
NSI1050	Isolated CAN transceiver	Isolated CAN communication
NSI1042	Isolated CAN transceiver	Isolated CAN communication
NSI83085	Half duplex RS485 transceiver	RS485 communication
NSI83086	Full duplex RS485 transceiver	RS485 communication
NCA3176	RS485 transceiver	RS485 communication
NCA3485	Half duplex RS485 transceiver	RS485 communication

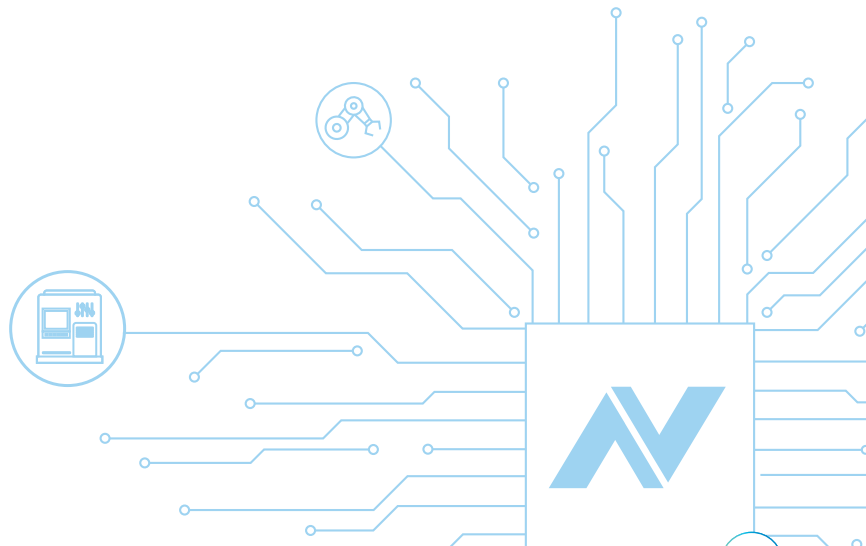



BTS Battery Component Capacity

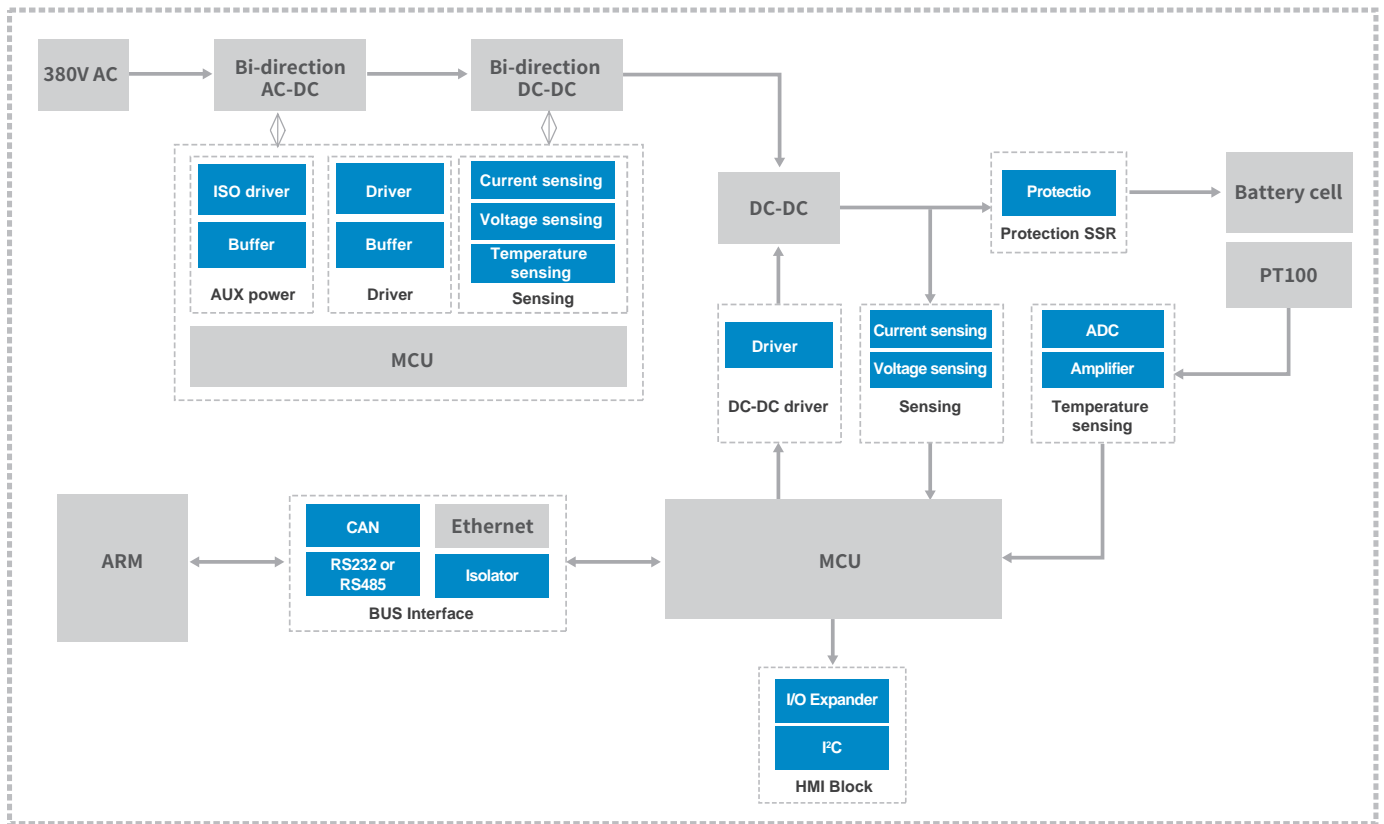

NOVOSENSE Part Number	Product Description	Application
NSM2011	Integrated Hall current sensor	PFC current detection, high-voltage battery charging current detection
NSM2013	Integrated Hall current sensor	PFC current detection, high-voltage battery charging current detection
NSM2015	Integrated Hall current sensor	PFC current detection, high-voltage battery charging current detection
NSM2017	Integrated Hall current sensor	PFC current detection, high-voltage battery charging current detection
NSM2019	Integrated Hall current sensor	PFC current detection, high-voltage battery charging current detection
NSM2113	Integrated Hall current sensor	PFC current detection, high-voltage battery charging current detection, resonant cavity current detection
NSI1300	Isolated amplifier	Isolated current sensing
NSI1200	Isolated amplifier	Isolated current sensing
NSCSA21x	Isolated amplifier	Achieve higher system accuracy, better feedback control and protection
NSCSA24x	Isolated amplifier	Achieve higher system accuracy, better feedback control and protection
NSCSA199	Isolated amplifier	Realize the amplification or regulation of voltage, current and power signals
NSOPA9xxx	40V high-voltage general-purpose operational amplifier	Signal amplification/ conditioning/ active filtering
NSOPA8xxx	5.5V low-voltage general-purpose operational amplifier	Signal amplification/ conditioning/ active filtering



NOVOSENSE Part Number	Product Description	Application
NSI1311	Isolated amplifier	Isolated voltage sensing
NSI1312	Isolated amplifier	Isolated voltage sensing
NST235	High linearity & high accuracy analog output temperature sensor	Temperature sensing
NST20	High linearity & high accuracy analog output temperature sensor	Temperature sensing
NSD1026V	High-speed, low-side, dual-channel non-isolated gate driver	MOS/IGBT/SiC non-isolated gate driver
NSD1624	High-voltage non-isolated half bridge gate driver	MOS/IGBT/SiC non-isolated gate driver
NSD1224	120V half-bridge gate driver	MOS/IGBT/SiC non-isolated gate driver
NCA8244	Buffer	Improve driver ability of bus-oriented receivers and transmitters, clock drivers
NSI8608	Isolated digital input	Isolated digital signal input
NSI824x	Digital isolator	Digital signal isolation
NSI1050	Isolated CAN transceiver	Isolated CAN communication
NSI1042	Isolated CAN transceiver	Isolated CAN communication
NCA1051A	CAN transceiver	CAN communication
NCA1042B	CAN transceiver	CAN communication
NSI83085	Half duplex RS485 transceiver	RS485 communication
NSI83086	Full duplex RS485 transceiver	RS485 communication
NCA3176	RS485 transceiver	RS485 communication
NCA3485	Half duplex RS485 transceiver	RS485 communication
NCA9555	I ² C GPIO expander	I ² C GPIO expander
NSI8100	I ² C digital isolator	Isolated I ² C communication
NSI8200	I ² C digital isolator	Isolated I ² C communication





Robust

Reliable

Keep Learning

Persist in Long-term Value

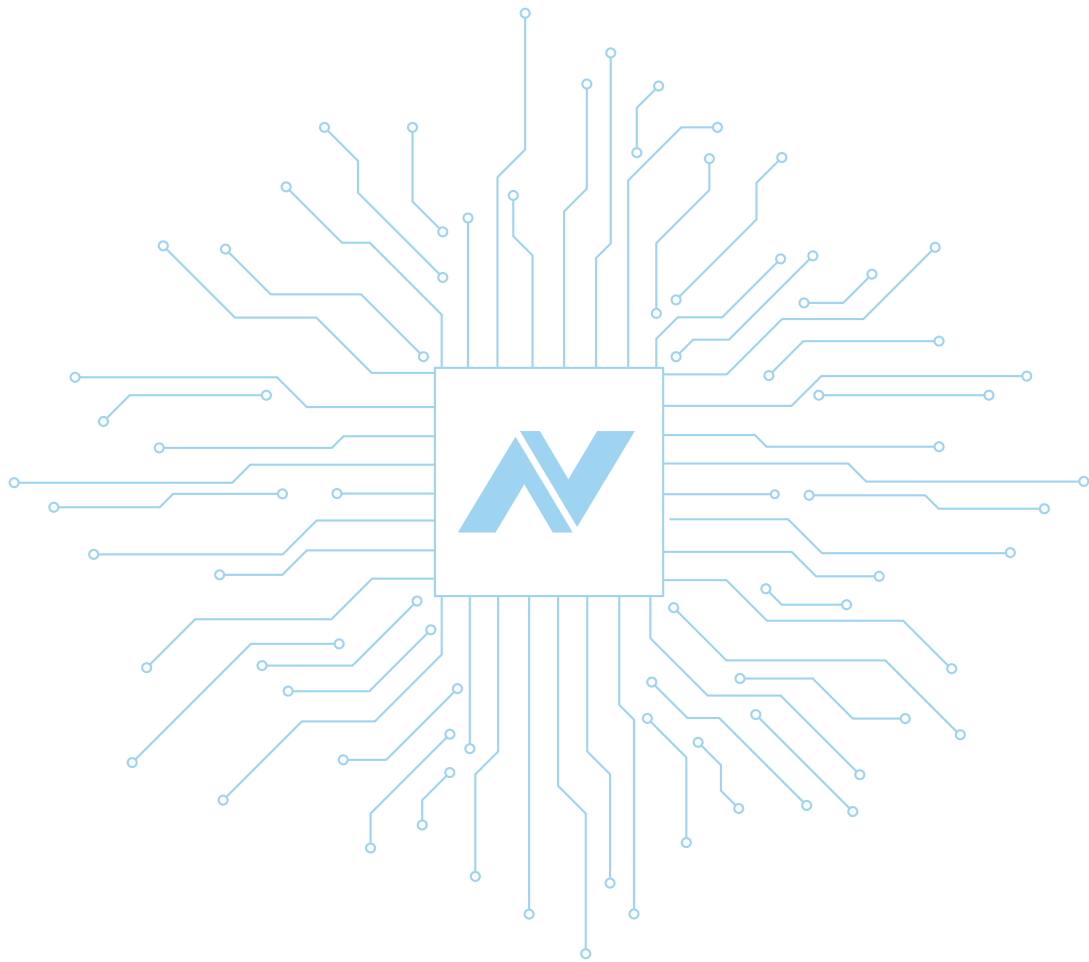

NOVOSENSE



NOVOSENSE
Company Brochure



NOVOSENSE
Product Selection Guide



NOVOSENSE
Automotive Solution



NOVOSENSE
Renewable Energy &
Power Supply Application
Solution



NOVOSENSE
Industrial
Control Solution

NOVOSENSE Microelectronics

✉ sales@novosns.com

🌐 www.novosns.com

📺 [NOVOSENSE Microelectronics](#)

📺 [NOVOSENSE Microelectronics](#)

Release Date: April 2024